



3 GHz TNC FAILSAFE S.P.D.T. SWITCH

OPTIONS:

R F CHARACTERISTICS

FREQUENCY RANGE : 0 - 3 GHz
 IMPEDANCE : 50 Ohms

FREQUENCY (GHz)	0 - 1	1 - 2	2 - 3
V.S.W.R <=	1.15	1.20	1.25
INSERT. LOSS <=	0.15 dB	0.20 dB	0.25 dB
ISOLATION >=	85 dB	80 dB	75 dB
AVER. POWER (*)	700 W	500 W	400 W

ELECTRICAL CHARACTERISTICS

ACTUATOR : FAILSAFE
 NOMINAL CURRENT AT 25° C (±10%) : 310 mA
 ACTUATOR VOLTAGE (Vcc) : 12V (10.2 to 13V)
 TERMINALS : solder pins (250 Deg.C max./30 sec)

MECHANICAL CHARACTERISTICS

CONNECTORS : TNC fem. per MIL C 39012
 LIFE : 1.000.000 cycles
 SWITCHING TIME (nominal voltage;25° C) : < 15 ms
 CONSTRUCTION : splashproof
 WEIGHT : < 185 g

ENVIRONMENTAL CHARACTERISTICS

OPERATING TEMPERATURE RANGE (°C) : -40 , +85
 STORAGE TEMPERATURE RANGE (°C) : -55 , +85

(* : average power at 25° C)

This information is given as an indication. In the continual goal to improve our products, we reserve the right to make any modifications judged necessary

4112-9212

DRAWING

General tolerance: * 0,5 mm

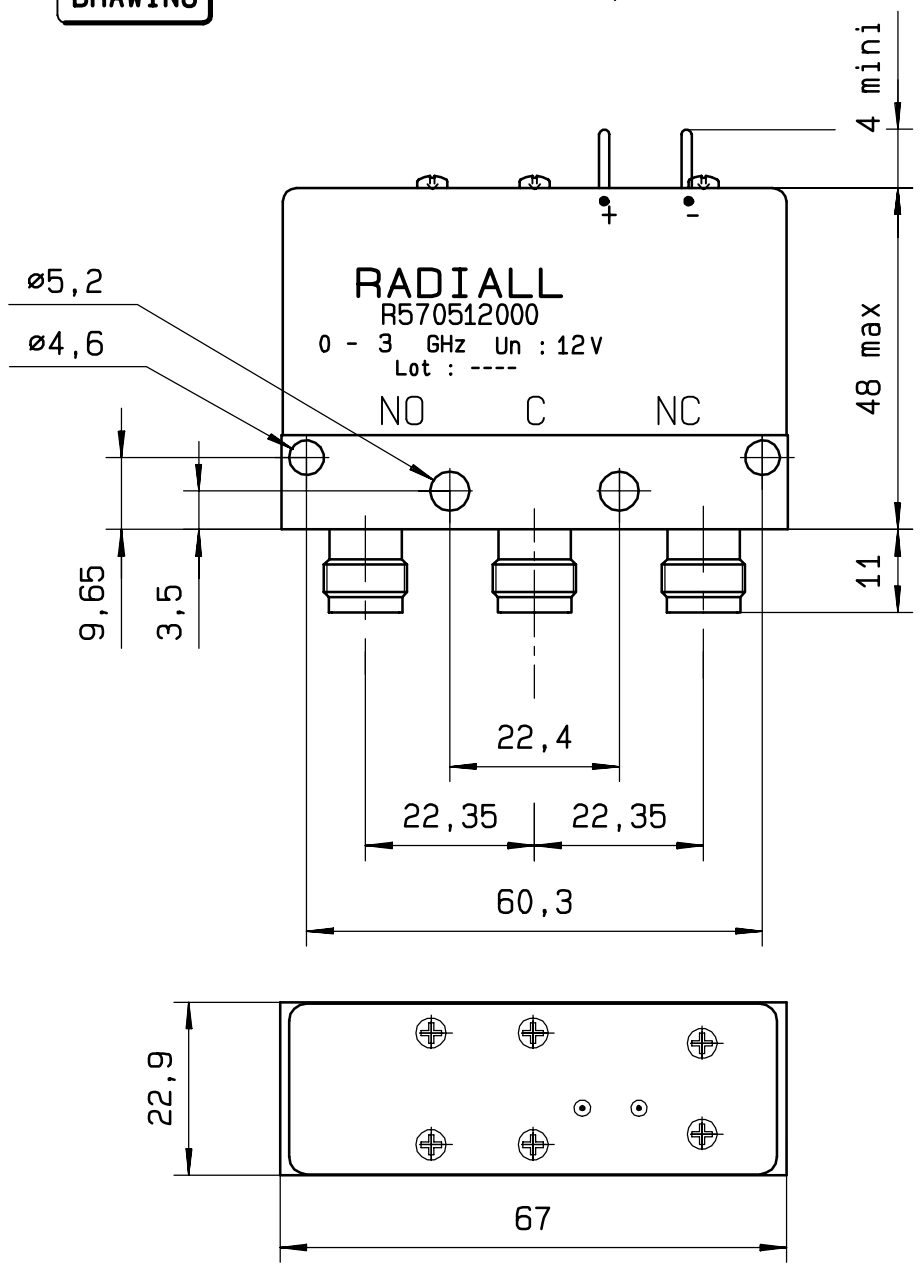

SCHEMATIC DIAGRAM

Voltage	RF continuity
De-energized	C ↔ NC
energized	C ↔ NO

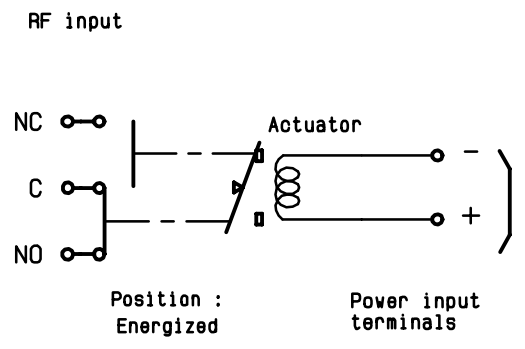

4113-9212 This information is given as an indication. In the continual goal to improve our products, we reserve the right to make any modifications judged necessary